

Before Amend

After Amend

Inspection for Environmental Protection:
Comply with EU RoHS standard and REACH SVHC substances of high off using the standard.

Electrical Test:

- A. 250V AC max, at 2A.
- B. Dielectric withstanding 1000V DC/min, <0.5A.
- C. Insulation Resistance: >500 MΩ, 1000V DC/min.
- D. Contact Resistance: <20 mΩ.

Mechanical:

- A. Cable-to-plug tensile strength-20LBS (89N) min.
- B. Durability: 2000 mating cycles.

Operating Temperature: -40°C~+125°C.

环保测试:

符合欧盟RoHS标准及REACH SVHC之高关物质使用标准。

电气特性:

- A. 250伏特AC, 最大2安培耐电压伏特数。
- B. 耐压测试: 小于0.5安培 1000伏特DC/一分钟。
- C. 绝缘抗阻: 1000伏特DC/一分钟, 大于500兆欧姆。
- D. 接触阻抗: 不大于20毫欧姆。

机械特性:

- A. 拉力测试: 电缆至插座张力强度至少一分钟20磅 (89N)。
- B. 耐力测试: 插拔测试2000次以上。

使用温度范围: -40°C~+125°C。

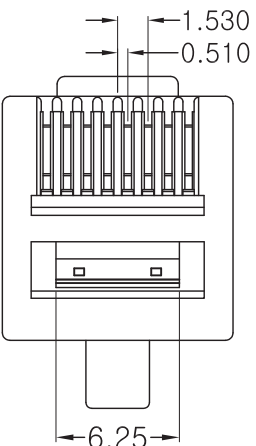
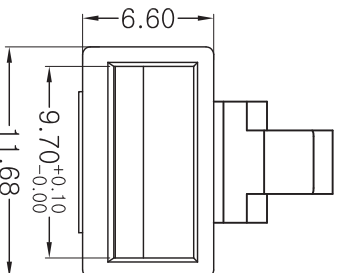
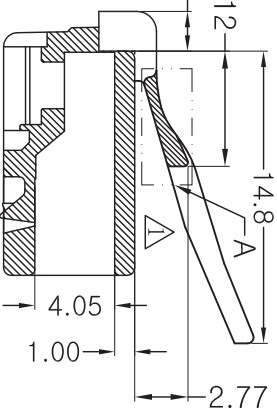
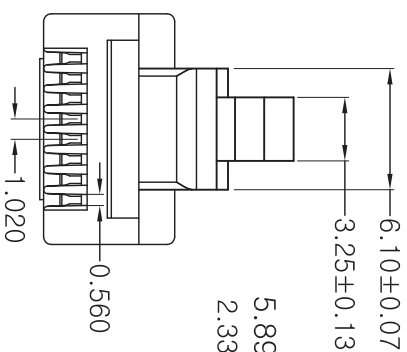

配件 (FITTINGS):

- MGC5KF5-05
- MGC5KF5-06
- MGC5KF6-05
- OTHER
- 磷铜

金片 TERMINAL	M2405A	M2333AS3				OTHER
图形 DRAWING						
标记 MARK						

镀金 GOLD PLATING	Fu"	1u"	3u"	6u"	15u"	30u"	50u"	OTHER
标记 MARK								

变更 CHANGE		变更日期 UPDATE DATE	签名 SIGNATURE
版本 EDIT	变更内容 MODIFICATION	2016.05.19	
A/1	产品拔出困难, 修改弹片形状		

Wider Cable

产品编号 PRODUCT NO	C6S5K9L	品名规格 DESCRIPTION	UTP/CAT6/单排/短身/长弹片		图号 DWG. NO	PEF083
材料 MATERIAL	PC	单位 UNIT	MM	比例 SCALE	版本 EDITION	A/1
尺寸公差表 DIMENSIONAL TOLERANCE	±0.2 ±0.10 ±0.050 ±2°	第三视角法 THIRD ANGLE PROJECTION		制图 DRAWN	日期 DATE	2016.05.19
角度 ANGLE		核对 CHECK		批准 APPROVAL	日期 DATE	

版本		变更内容		变更日期		签名	
EDITION	CHANGE	MODIFICATION	UPDATE DATE	SIGNATURE			

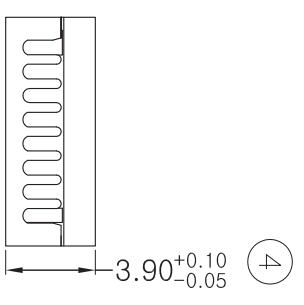
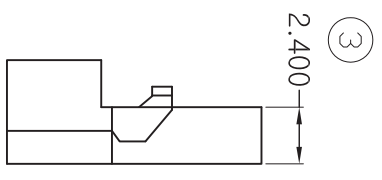
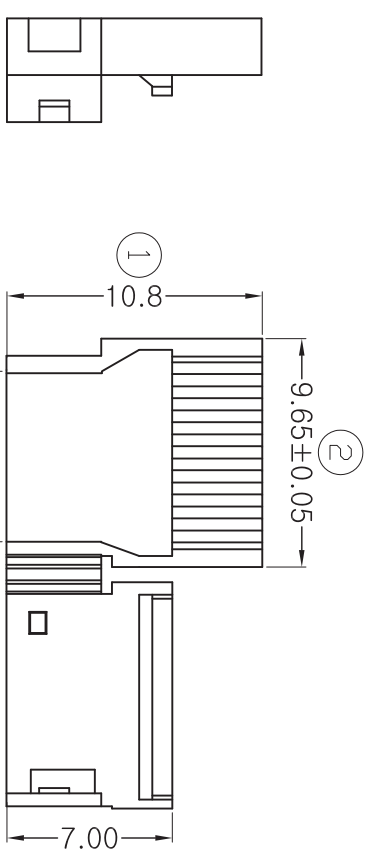
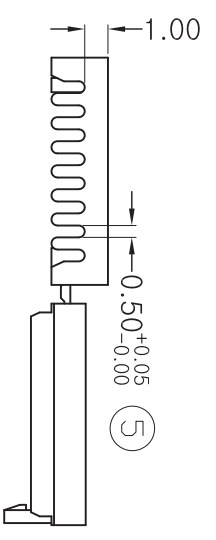

产品扣起来的高度尺寸

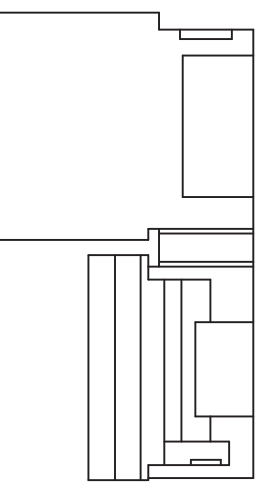
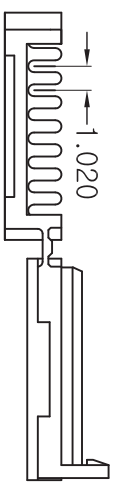

印章

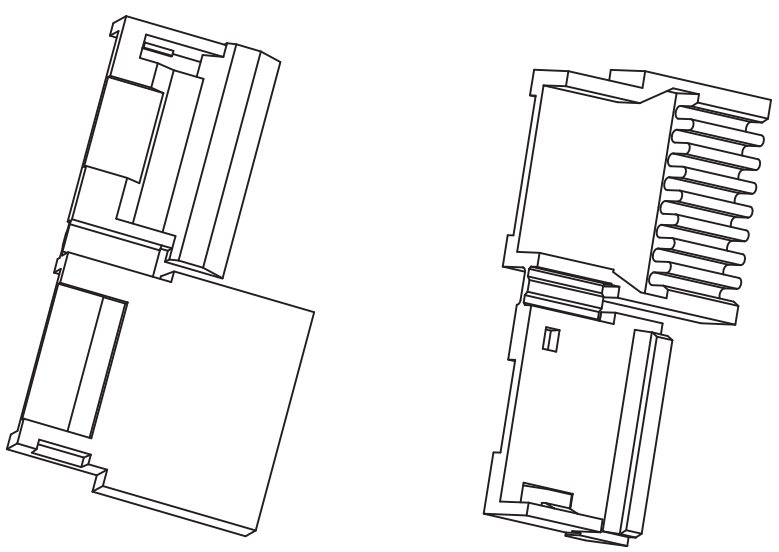

Wider Cable

产品编号 PRODUCT NO	MGC5KF5-05		品名规格 DESCRIPTION	折叠式/单排/1套		图号 DWG NO	PLK009
材质 MATERIAL	PC		单位 UNIT	MM		版本 EDITION	A/0
尺寸公差表 DIMENSIONAL TOLERANCE	±0.2 ±0.10 ±0.050		第三视角法 THIRD ANGLE PROJECTION	制图 DRAWN		日期 DATE	2015.05.11
X.X X.XX X.XXX ANGULAR	±2°			核对 CHECK	<i>Mix Lee</i>	日期 DATE	
				批准 APPROVAL		日期 DATE	